

Datasheet

Thermal Flow Switch F20

Introduction

F20 equips two temperature sensors, one is for the liquid temperature, the other one is heated a few degrees over the medium. Based on the principle of heat transfer, where the heated sensor within the fluid flow experiences cooling proportional to the flow velocity; the faster the fluid flows, the more heat is carried away from the sensor, resulting in a measurable temperature difference which can be used to determine the flow rate and trigger a switch action when it reaches a preset threshold.



Characteristics

- 330° rotatable display
- 8 LEDs for flow trend and switch state
- Compact design
- Pressure rating 1450 psi (100 bar)
- Applicable to water, gas or oil

Applications

- Hydraulic and lubrication system
- Pump protection
- Cooling system
- Venting system
- Water treatment
- Leak monitoring

Specifications

Set point range	Water: 0.03...5 ft/s (1...150 cm/s)
	Oil: 0.1...10 ft/s (3...300 cm/s)
	Gas: 0.65...65 ft/s (20...2000 cm/s)
Medium	Water / Oil / Gas
Repeatability	1% @ <0.6 m/s (2 ft/s)
	3% @ <1.5 m/s (5 ft/s)
	10% @ >1.5 m/s (5 ft/s)
Pressure rating	1450 psi (100 bar)
Initialization time	1...8 s
Power supply	18...30 VDC
Output	Relay (NC + NO)
	PNP (NC + NO)
	NPN (NC + NO)
Wiring protection	Reverse polarity, Overvoltage and Short-circuit
Display	1 red LED (Flow velocity < switch point)
	1 yellow LED (Flow velocity = switch point)
	4 green LEDs (Flow velocity > switch point)
Medium temperature	-4...176°F (-20...80°C)
Ambient temperature	-4...176°F (-20...80°C)
Storage temperature	-4...185°F (-20...85°C)
Material	Housing: Aluminum
	Probe: stainless steel
Electrical connection	M12 x 1
Protection class	IP65

Wiring

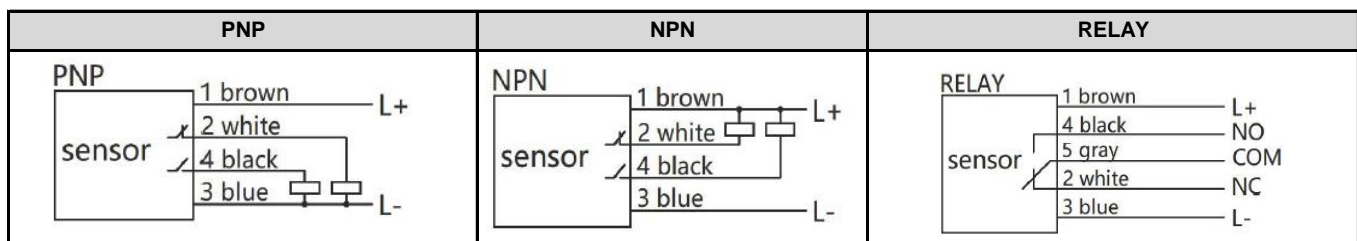

Pin	Cable	Terminal
1	Brown	Power +
2	White	NC
3	Blue	Power -
4	Black	NO
5	Gray	Relay terminal

LED function and Setup

	No flow or current flow is below set point
	Current flow reaches set point
	Current flow is higher than set point. More green LEDs means higher flow rate.

Mount the switch and let the medium flows as desired monitoring value, adjust potentiometer till the yellow LED turns on.

Once above is done, the switch will change state if the flow is below desired value.

To make set point lower than current flow rate, simply adjust potentiometer to have more green LEDs on.

*** Note:**

If red light is always on, adjust potentiometer clockwise till the first green light is on.

If all green lights are always on, adjust potentiometer counter clockwise till the red light is on.

Dimensions in mm

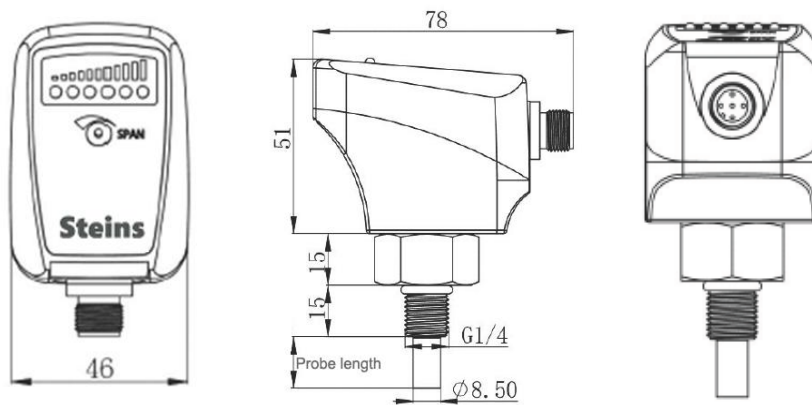

*** Note:**

These dimensions are for G1/4 thread connection, other thread on request.

Probe length L is 13mm by default, other length on request.

Mounting considerations

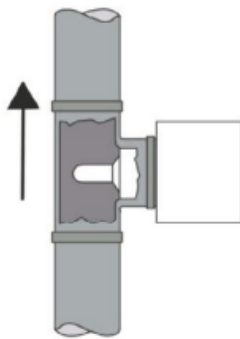

For vertical mount, make sure medium flows upward. At least half of probe should be immersed into medium.

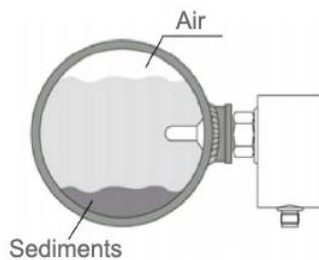

For horizontal mount, avoid probe touching air or sediments. At least half of probe should be immersed in the medium.

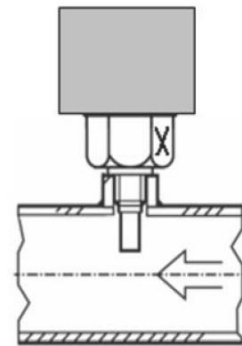

When mounting, the mark "X" should always face flow direction to have the best performance.

Order Code

Example: F20-G12L13PR

1. Model

F20- Thermal flow switch

2. Process connection

G14 1/4" male G thread
 G12 1/2" male G thread
 N14 1/4" male NPT thread
 N12 1/2" male NPT thread
 M18 M18 x 1.5 coupling

3. Probe Length

L13 13mm
 Sxx Please use Sxx for customized probe.
 "xxx" is in mm (up to 60mm).

4. Output

PR PNP (NC+NO)
 NR NPN (NC+NO)
 CR Relay (NC+NO)

Accessory - power/signal cable with socket

1. Connecting cable with socket

ET04- 4-pin M12 x 1 connecting cable with socket
 ET05- 5-pin M12 x 1 connecting cable with socket
 5-pin cable is for relay output



2. Material

PU Material: PUR

3. Length

02 6.5ft / 2m (default)
 05 16.5ft / 5m

4. Type

R Regular cable
 S Shielded cable

5. Connector

G Straight socket
 W Angled socket

Accessory - wirable plug

1. Wirable plug

ST05 5-pin M12 x 1 wirable plug



Accessory - Welding socket

1. Model

TT01- Welding socket

2. Thread

- G14 Fitting thread: 1/4" G thread
- G12 Fitting thread: 1/2" G thread
- N14 Fitting thread: 1/4" NPT thread
- N12 Fitting thread: 1/2" NPT thread

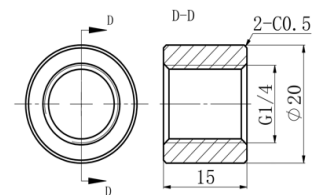
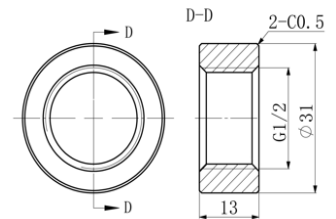

Accessory - Adaptor for M18 coupling

1. Model

TT02- Adaptor for M18 x 1.5 to G or NPT thread

2. Thread

- G14 M18 x 1.5 to 1/4" G thread
- G12 M18 x 1.5 to 1/2" G thread
- N14 M18 x 1.5 to 1/4" NPT thread
- N12 M18 x 1.5 to 1/2" NPT thread

